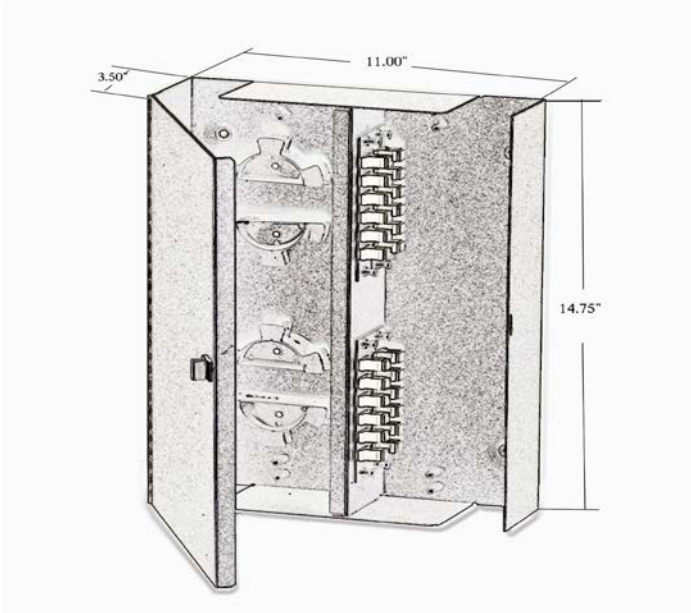

Re: WXL Series Wall Mount Fiber Optic Enclosures**Specifications: Part NO. WXL-4 Fiber Optic Wall Mount Enclosure****(Document No.019007) 02-27-19 Rev.1**

Part Number	Description
-------------	-------------

WXL-4 **Four Module Fiber Optic Wall Mount Enclosure**
Accepts: 4ea. LGX-118 Type Fiber Optic Insert Modules and
up to 2ea. 24 Fiber Stackable Fusion Splice Trays.
Dimensions: 14.75" H x 11.00" W x 3.5" D
Weight: 9 lbs. Approx.

Features

- USA Made (16 Ga. Steel)
- Durable Epoxy Powder Coated Finish (Black)
- 1 to 4 Fiber LGX-118 Type Insert Modules
- Top and Bottom Cable Entry
- Fiber Management Spools included
- Thru hole locking front door feature for padlock
- Continuous left side hinged front door
- Accommodates 2ea 24 Fiber Fusion of Splice Trays